

**PROPRIETARY NOTE**

THIS SPECIFICATION IS THE PROPERTY OF BOE BJ AND SHALL NOT BE REPRODUCED OR COPIED WITHOUT THE WRITTEN PERMISSION OF BOE BJ AND MUST BE RETURNED TO BOE BJ UPON ITS REQUEST



SPEC. NUMBER

PRODUCT GROUP

Rev.

ISSUE DATE

PAGE

TLCM

P1

2016.08.12

1 OF 32

**NV156FHM-T00**

**Preliminary Product Specification**

**Rev. P1**

CHONGQING BOE OPTOELECTRONICS TECHNOLOGY CO.,LTD

PRODUCT GROUP

REV

ISSUE DATE



TLCM PRODUCT

P1

2016.08.12

SPEC. NUMBER

SPEC. TITLE

PAGE

NV156FHM-T00 Preliminary Product Specification

2 OF 32

REVISION HISTORY

REV.	ECN No.	DESCRIPTION OF CHANGES	DATE	PREPARED
P0	-	Initial Release	2016.05.06	Xuzhijun zuocheng
P1	-	EDID update, Add Touch Timing	2016.8.12	Xuzhijun wangxiaojun

PRODUCT GROUP

REV

ISSUE DATE



TLCM PRODUCT

P1

2016.08.12

SPEC. NUMBER

SPEC. TITLE

NV156FHM-T00 Preliminary Product Specification

PAGE

3 OF 32

# Contents

No.	Items	Page
	REVISION HISTORY	2
	CONTENTS	3
1.0	General Description	4
2.0	Absolute Maximum ratings	6
3.0	Electrical specifications.	7
4.0	Optical specifications.	10
5.0	Interface Connection	15
6.0	Signal Timing Specification	18
7.0	Input Signals, Basic Display Colors & Gray Scale of Colors	20
8.0	Power Sequence	21
9.0	Mechanical Characteristics	22
10.0	Reliability Test	23
11.0	Handling & Cautions.	23
12.0	Label	24
13.0	Packing information	25
14.0	Mechanical Outline Dimension	27
15.0	EDID Table	29

## 1.0 General Description

### 1.1 Application

- Notebook PC With Touch function

### 1.2 General Specification

#### 1.2.1. General LCM Specification (Table 1.)

<Table 1. General LCM Specifications>

Parameter	Specification	Unit	Remarks
Active area	344.16 (H) × 193.59 (V)	mm	
Number of pixels	1920 (H) × 1080 (V)	pixels	
Pixel pitch	0.17925 (H) X 0.17925 (V)	mm	
Pixel arrangement	RGB Vertical stripe		
Display colors	262K	colors	
Display mode	Normally Black		
Outline Dimension	350.76(H) × 205.825(V)	mm	
Weight	385 (max)	g	
Back-light	Lower Down side, 1-LED Lighting Bar type		Note 1
Power consumption	P <sub>D</sub> : 0.9	W	@mosaic
	P <sub>BL</sub> : 3.6	W	
	P <sub>total</sub> :4.5	W	@mosaic

1.2.2.General Touch Specification(Table 2.)

<Table 2. General Touch Specifications>

Parameter	Specification	Unit	Remarks
Type of Touch Sensor	Self Capacitance		
Touch Structure	On Cell		
Panel Size	15.6"		
Outline Dimension	N/A(Cover Lens Free)	mm	
TP View Area	N/A(Cover Lens Free)	mm	
TP Active Area	X 345.96 × Y 193.74	mm	
Total Thickness	N/A(Cover Lens Free)	mm	
Interface	USB		
Report Rate	Follow win8 – 100Hz		
Multi-Touch Point	10 points		
Input method	Finger		
Touch panel sensor IC	G7500		
Channel	1500		
Surface treatment	Normal AG		
Surface Hardness	3	H	
Support OS	Win8.x and Win10 compliant		
TP Power Consumption	200 max.	mW	@ 5 finger

## 2.0 ABSOLUTE MAXIMUM RATINGS

The followings are maximum values which, if exceed, may cause faulty operation or damage to the unit. The operational and non-operational maximum voltage and current values are listed in Table 3.

< Table 3. Absolute Maximum Ratings >

Ta=25+/-2°C

Parameter	Symbol	Min.	Max.	Unit	Remarks
Power Supply Voltage	V <sub>DD</sub>	-0.3	4.0	V	Note 1
Logic Supply Voltage	V <sub>IN</sub>	V <sub>SS</sub> -0.3	V <sub>DD</sub> +0.3	V	
Operating Temperature	T <sub>OP</sub>	0	+50	°C	Note 2
Storage Temperature	T <sub>ST</sub>	-20	+60	°C	

- Notes : 1. Permanent damage to the device may occur if maximum values are exceeded functional operation should be restricted to the condition described under normal operating conditions.
2. Temperature and relative humidity range are shown in the figure below.  
 95 % RH Max. ( 40 °C ≥ Ta)  
 Maximum wet - bulb temperature at 39 °C or less. (Ta > 40 °C) No condensation.

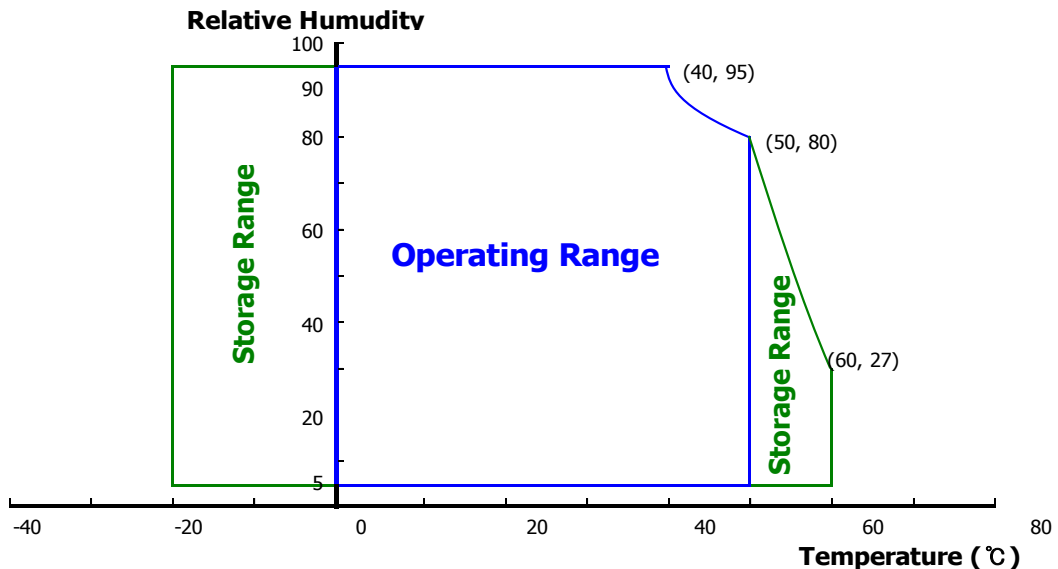

### 3.0 ELECTRICAL SPECIFICATIONS

#### 3.1 Electrical Specifications

&lt; Table 4. Electrical specifications &gt;

Ta=25+/-2°C

Parameter		Min.	Typ.	Max.	Unit	Remarks
Power Supply Voltage	V <sub>DD</sub>	3.0	3.3	3.6	V	Note 1
Permissible Input Ripple Voltage	V <sub>RF</sub>	-	-	100	mV	At V <sub>DD</sub> = 3.3V
Power Supply Current	I <sub>DD</sub>	-	-	273	mA	Note 1
Differential Input Voltage	V <sub>ID</sub>	100	-	600	mV	
Power Consumption	P <sub>D</sub>	-	-	0.9	W	Note 1
	P <sub>BL</sub>	-	-	3.6	W	Note 2
	P <sub>total</sub>	-	-	4.5	W	

Notes : 1. The supply voltage is measured and specified at the interface connector of LCM.  
The current draw and power consumption specified is for 3.3V at 25°C.

a) Typ : Mosaic Pattern

b) Max : Skip sub pixel255

2. Calculated value for reference (VLED × ILED)

**3.2 Backlight Unit**

< Table 5. LED Driving guideline specifications >

Ta=25+/-2°C

Parameter		Min.	Typ.	Max.	Unit	Remarks
LED Forward Voltage	V <sub>F</sub>	-	-	3.3	V	-
LED Forward Current	I <sub>F</sub>	-	23	-	mA	-
LED Power Consumption	P <sub>LED</sub>	-	-	3.6	W	Note 1
LED Life-Time	N/A	15,000	-	-	Hour	I <sub>F</sub> = 23mA
Power supply voltage for LED Driver	V <sub>LED</sub>	5	12	21	V	
EN Control Level	Backlight on	2.5		5.0	V	
	Backlight off	0		1.0	V	
PWM Control Level	PWM High Level	2.5		5.0	V	
	PWM Low Level	0		0.1	V	
PWM Control Frequency	F <sub>PWM</sub>	100	-	10,000	Hz	
Duty Ratio	-	1	-	100	%	Note3

Notes : 1. Power supply voltage 12V for LED Driver

Calculator Value for reference  $I_F \times V_F \times 36 / \text{efficiency} = P_{LED}$

2. The LED Life-time define as the estimated time to 50% degradation of initial luminous.

3. 1% duty cycle is achievable with a dimming frequency less than 1KHz.



**3.3 LED structure**

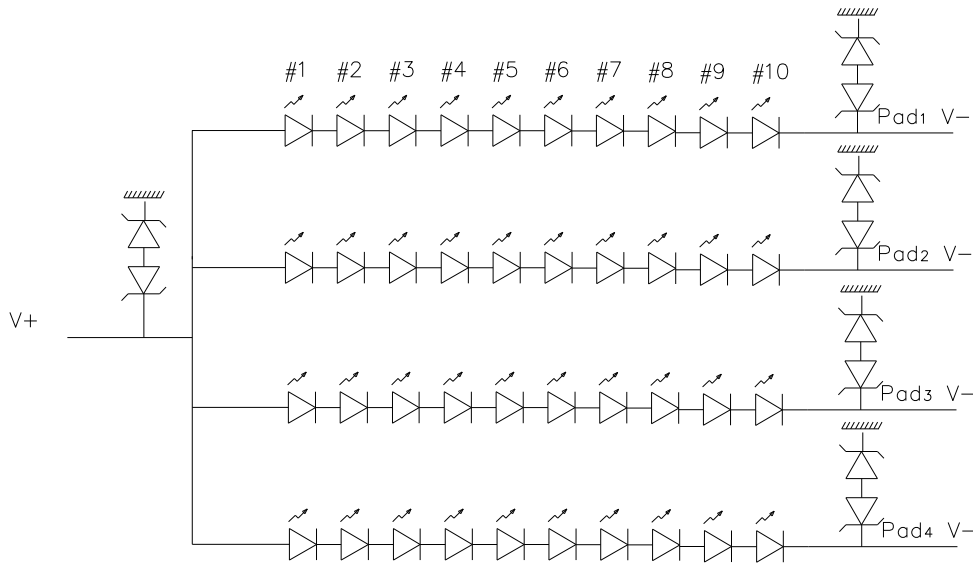

PRODUCT GROUP		REV	ISSUE DATE	<b>BOE</b>
TLCM PRODUCT		P1	2016.08.12	
SPEC. NUMBER	SPEC. TITLE			PAGE
	NV156FHM-T00 Preliminary Product Specification			10 OF 32

**4.0 OPTICAL SPECIFICATION**

**4.1 Overview**

The test of Optical specifications shall be measured in a dark room (ambient luminance  $\leq 1$  lux and temperature =  $25\pm 2^\circ\text{C}$ ) with the equipment of Luminance meter system (Goniometer system and TOPCON BM-5) and test unit shall be located at an approximate distance 50cm from the LCD surface at a viewing angle of  $\theta$  and  $\Phi$  equal to  $0^\circ$ . We refer to  $\theta\Phi=0$  ( $=\theta 3$ ) as the 3 o'clock direction (the "right"),  $\theta\Phi=90$  ( $=\theta 12$ ) as the 12 o'clock direction ("upward"),  $\theta\Phi=180$  ( $=\theta 9$ ) as the 9 o'clock direction ("left") and  $\theta\Phi=270$  ( $=\theta 6$ ) as the 6 o'clock direction ("bottom"). While scanning  $\theta$  and/or  $\Phi$ , the center of the measuring spot on the Display surface shall stay fixed. The backlight should be operating for 30 minutes prior to measurement. VDD shall be  $3.3\pm 0.3\text{V}$  at  $25^\circ\text{C}$ . Optimum viewing angle direction is 6 'clock.

**4.2 Optical Specifications**

<Table 6. Optical Specifications>

Parameter		Symbol	Condition	Min.	Typ.	Max.	Unit	Remark
Viewing Angle range	Horizontal	$\Theta_3$	CR > 10	-	85	-	Deg.	Note 1
		$\Theta_9$		-	85	-	Deg.	
	Vertical	$\Theta_{12}$		-	85	-	Deg.	
		$\Theta_6$		-	85	-	Deg.	
Luminance Contrast ratio		CR	$\Theta = 0^\circ$	-	800			Note 2
Luminance of White	5 Points	$Y_w$	$\Theta = 0^\circ$ $I_{LED} = 23.0\text{mA}$	210	250	-	cd/m <sup>2</sup>	Note 3
White Luminance uniformity	5 Points	$\Delta Y_5$		80%	-	-		Note 4
	13 Points	$\Delta Y_{13}$		60%	-	-		
White Chromaticity		$x_w$	$\Theta = 0^\circ$	0.283	0.313	0.343		Note 5
		$y_w$		0.299	0.329	0.359		
Reproduction of color	Red	$x_R$	$\Theta = 0^\circ$	-0.03	0.585	+0.03		
		$y_R$			0.364			
	Green	$x_G$			0.350			
		$y_G$			0.580			
	Blue	$x_B$			0.163			
		$y_B$			0.143			
Gamut					45		%	
Response Time (Rising + Falling)		$T_{RT}$	$T_a = 25^\circ\text{C}$ $\Theta = 0^\circ$	-	30	35	ms	Note 6
Cross Talk		CT	$\Theta = 0^\circ$	-	-	2.0	%	Note 7

PRODUCT GROUP		REV	ISSUE DATE	<b>BOE</b>
TLCM PRODUCT		P1	2016.08.12	
SPEC. NUMBER	SPEC. TITLE			PAGE
	NV156FHM-T00 Preliminary Product Specification			11 OF 32

Notes :

1. Viewing angle is the angle at which the contrast ratio is greater than 10. The viewing angles are determined for the horizontal or 3, 9 o'clock direction and the vertical or 6, 12 o'clock direction with respect to the optical axis which is normal to the LCD surface (see FIGURE 1).

2. Contrast measurements shall be made at viewing angle of  $\Theta = 0$  and at the center of the LCD surface. Luminance shall be measured with all pixels in the view field set first to white, then to the dark (black) state .

(see FIGURE 1) Luminance Contrast Ratio (CR) is defined mathematically.

$$CR = \frac{\text{Luminance when displaying a white raster}}{\text{Luminance when displaying a black raster}}$$

3. Center Luminance of white is defined as luminance values of 5 point average across the LCD surface. Luminance shall be measured with all pixels in the view field set first to white. This measurement shall be taken at the locations shown in FIGURE 2 for a total of the measurements per display.

4. The White luminance uniformity on LCD surface is then expressed as :  $\Delta Y = \text{Minimum Luminance of 5(or 13) points} / \text{Maximum Luminance of 5(or 13) points}$ .

(see FIGURE 2 and FIGURE 3).

5. The color chromaticity coordinates specified in Table 5 shall be calculated from the spectral data measured with all pixels first in red, green, blue and white. Measurements shall be made at the center of the panel.

6. The electro-optical response time measurements shall be made as FIGURE 4 by switching the "data" input signal ON and OFF. The times needed for the luminance to change from 10% to 90% is  $T_r$ , and 90% to 10% is  $T_d$ .

7. Cross-Talk of one area of the LCD surface by another shall be measured by comparing the luminance ( $Y_A$ ) of a 25mm diameter area, with all display pixels set to a gray level, to the luminance ( $Y_B$ ) of that same area when any adjacent area is driven dark.

(See FIGURE 5).

PRODUCT GROUP		REV	ISSUE DATE	<b>BOE</b>
TLCM PRODUCT		P1	2016.08.12	
SPEC. NUMBER	SPEC. TITLE			PAGE
	NV156FHM-T00 Preliminary Product Specification			12 OF 32

**4.3 Optical measurements**

**Figure 1. Measurement Set Up**

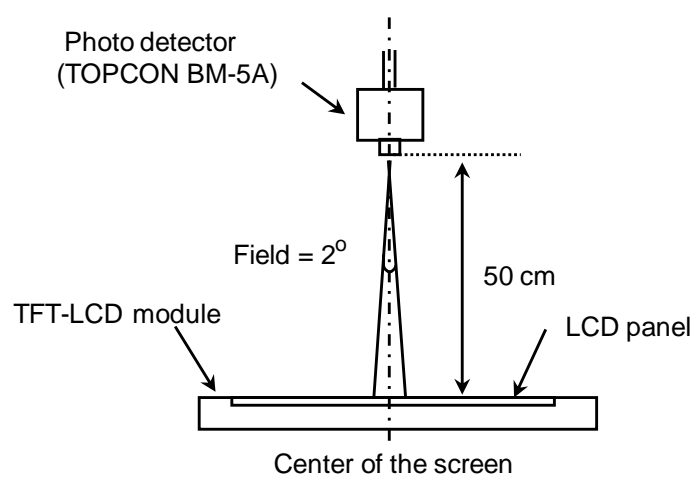

Optical characteristics measurement setup

**Figure 2. White Luminance and Uniformity Measurement Locations (5 points)**

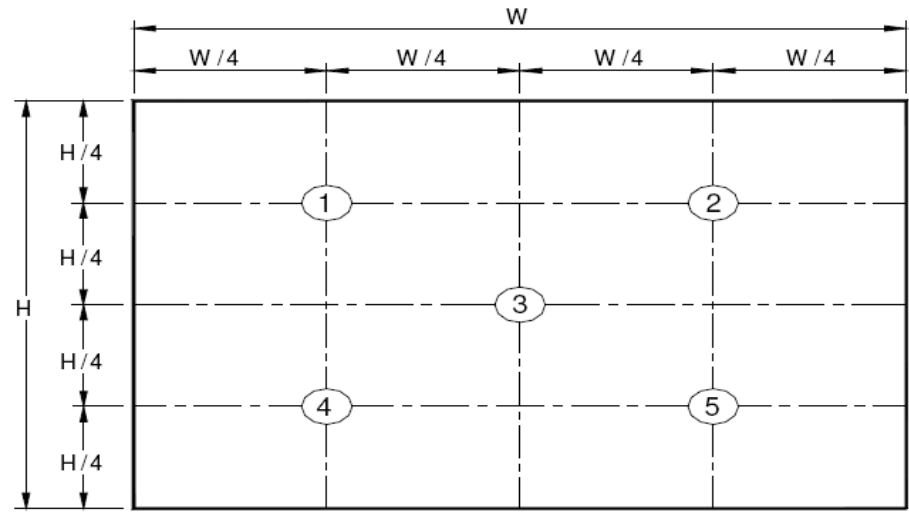

Center Luminance of white is defined as luminance values of center 5 points across the LCD surface. Luminance shall be measured with all pixels in the view field set first to white. This measurement shall be taken at the locations shown in FIGURE 2 for a total of the measurements per display.

PRODUCT GROUP		REV	ISSUE DATE	<b>BOE</b>
TLCM PRODUCT		P1	2016.08.12	
SPEC. NUMBER	SPEC. TITLE			PAGE
	NV156FHM-T00 Preliminary Product Specification			13 OF 32

**Figure 3. Uniformity Measurement Locations (13 points)**

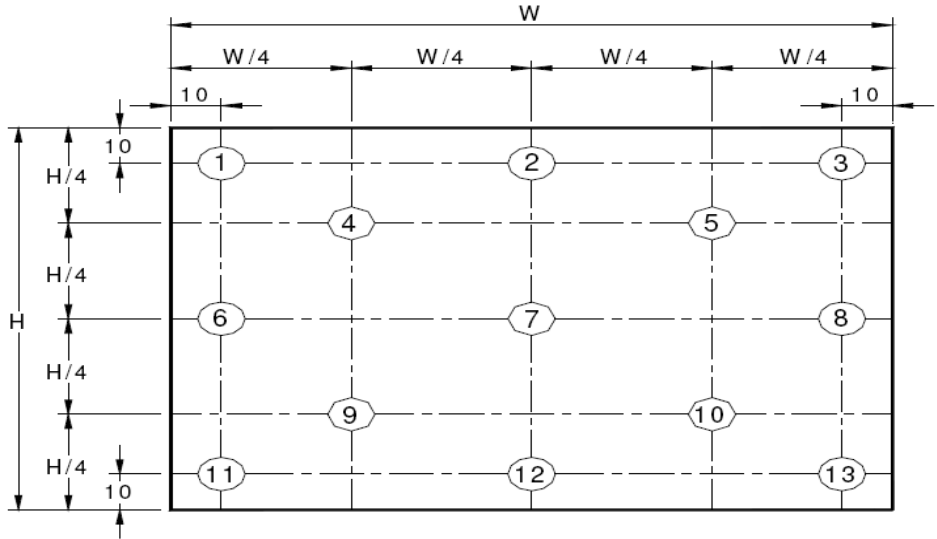

The White luminance uniformity on LCD surface is then expressed as :  $\Delta Y5 = \text{Minimum Luminance of five points} / \text{Maximum Luminance of five points}$  (see FIGURE 2) ,  $\Delta Y13 = \text{Minimum Luminance of 13 points} / \text{Maximum Luminance of 13 points}$  (see FIGURE 3).

**Figure 4. Response Time Testing**

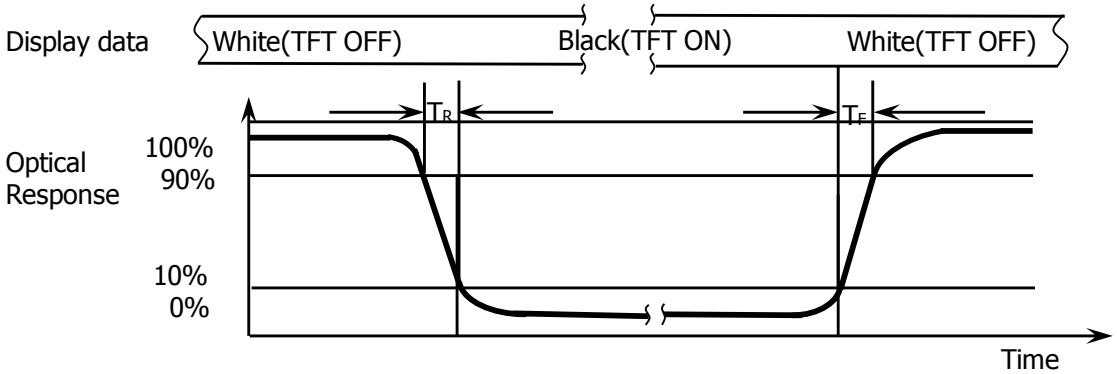

The electro-optical response time measurements shall be made as shown in FIGURE 4 by switching the “data” input signal ON and OFF. The times needed for the luminance to change from 10% to 90% is  $T_d$  and 90% to 10% is  $T_r$ .

**Figure 5. Cross Modulation Test Description**

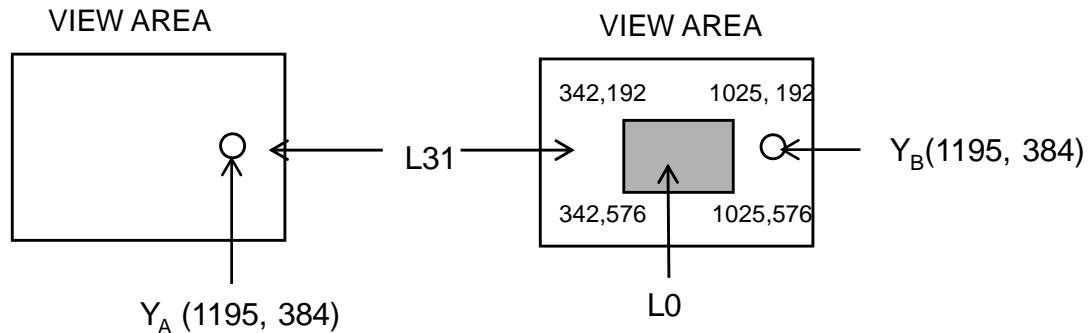

$$\text{Cross-Talk (\%)} = \left| \frac{Y_B - Y_A}{Y_A} \right| \times 100$$

Where:

$Y_A$  = Initial luminance of measured area (cd/m<sup>2</sup>)

$Y_B$  = Subsequent luminance of measured area (cd/m<sup>2</sup>)

The location measured will be exactly the same in both patterns

Cross-Talk of one area of the LCD surface by another shall be measured by comparing the luminance ( $Y_A$ ) of a 25mm diameter area, with all display pixels set to a gray level, to the luminance ( $Y_B$ ) of that same area when any adjacent area is driven dark (Refer to FIGURE 5).

**5.0 INTERFACE CONNECTION.****5.1 Electrical Interface Connection**

The electronics interface connector is **20525-040E-02**.

The connector interface pin assignments are listed in Table 7.

<Table 7. Pin Assignments for the Interface Connector>

PIN NO	Symbol Function	PIN NO	Symbol Function
1	CABC_ENIN	21	LED Ground
2	Ground	22	LED enable pin(+3.3V Input)
3	eDP RX channel 1 negative	23	System PWM Signal Input
4	eDP RX channel 1 positive	24	Line synchronization
5	Ground	25	No Connection
6	eDP RX channel 0 negative	26	LED Power Supply 5V-21V
7	eDP RX channel 0 positive	27	LED Power Supply 5V-21V
8	Ground	28	LED Power Supply 5V-21V
9	eDP AUX CH positive	29	LED Power Supply 5V-21V
10	eDP AUX CH negative	30	No Connection
11	Ground	31	No Connection
12	Power Supply, 3.3V (typ.)	32	No Connection
13	Power Supply, 3.3V (typ.)	33	No Connection
14	Panel self test enable	34	No Connection
15	Ground	35	Ground
16	Ground	36	D+
17	Hot plug detect output	37	D-
18	LED Ground	38	Ground
19	LED Ground	39	Touch enable
20	LED Ground	40	Touch power supply 3.3V

PRODUCT GROUP		REV	ISSUE DATE	<b>BOE</b>
TLCM PRODUCT		P1	2016.08.12	
SPEC. NUMBER	SPEC. TITLE			PAGE
	NV156FHM-T00 Preliminary Product Specification			16 OF 32

**5-2. eDP Interface**

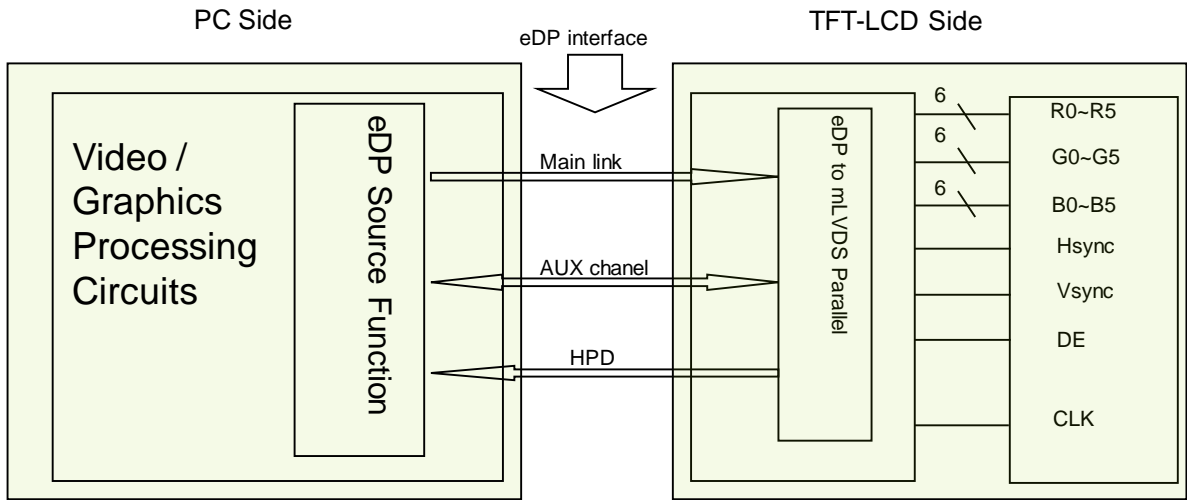

Note. Transmitter : Novatek NT71832 or equivalent.  
 Transmitter is not contained in Module.

**5.3.eDP Input signal**

Lane 0	
R0-5:0	G0-5:4
G0-3:0	B0-5:2
B0-1:0	R1-5:0
G1-5:0	B1-5:4
B1-3:0	R2-5:2
R2-1:0	G2-5:0
B2-5:0	R3-5:4
R3-3:0	G3-5:2
G3-1:0	B3-5:0



**5.4 Back-light & LCM Interface Connection**

<Table 8. Pin Assignments for the BLU & LCM Connector>

Pin No.	Symbol	Description	Pin No.	Symbol	Description
1	Vout	LED anode connection	6	NC	NC Connection
2	Vout	LED anode connection	7	LED1	LED cathode connection
3	Vout	LED anode connection	8	LED2	LED cathode connection
4	NC	NC	9	LED3	LED cathode connection
5	NC	NC	10	LED4	LED cathode connection

## 6.0 SIGNAL TIMING SPECIFICATION

6.1 The NV156FHM-T00 is operated by the DE only.

Item		Symbols	Min	Typ	Max	Unit
Clock	Frequency	1/Tc	100	152.6	160	MHz
Frame Period		Tv	1112	1125	1238	lines
			-	60	-	Hz
			25	16.67	15.15	ms
Vertical Display Period		Tvd	-	1080	-	lines
One line Scanning Period		Th	2080	2230	2400	clocks
Horizontal Display Period		Thd	-	1920	-	clocks

**6.2 eDP Rx Interface Timing Parameter**

The specification of the eDP Rx interface timing parameter is shown in Table 9.

<Table 9.1 eDP Rx Interface Timing Specification>

Item	Symbol	Min	Typ	Max	Unit	Remark
Spread spectrum clock	ssc		0.5		%	
Differential peak-to-peak input voltage at package pins	VRX-DIFFp-p	500	0	1000	mV	
Rx input DC common mode voltage	VRX_DC_CM	-	GND	-	V	
Differential termination resistance	RRX-DIFF	80	-	100	$\Omega$	
Single-ended termination resistance	RRX-SE	40	-	60	$\Omega$	
Rx short circuit current limit	IRX_SHORT	-	-	20	mA	
Intra-pair skew at Rx package pins (HBR) RX intra-pair skew tolerance at HBR	LRX_SKEW_INTRA_PAIR	-	-	150	ps	

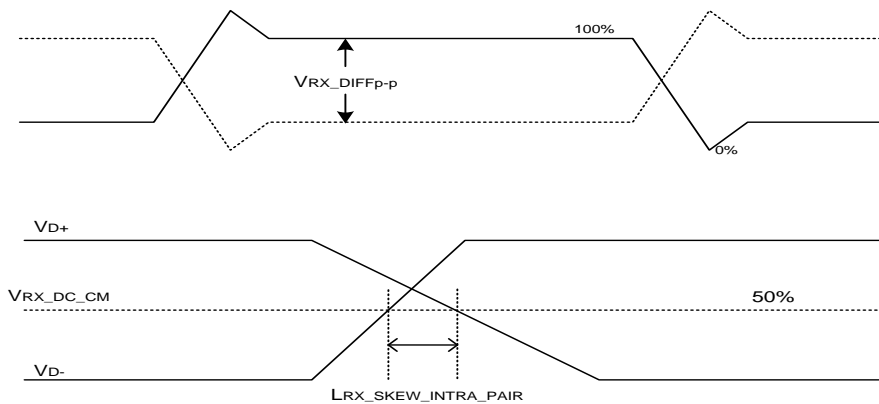

**6.3 Touch Interface Timing Parameter**

The specification of the Touch interface timing parameter is shown in Table 9.2

<Table 9.2 Touch Interface Timing Specification>

ITEM	Symbol	Time	Unit
MCU Power ON ~ MCU Reset(MCU Internal Reset)	T1	≥400us	us
MCU Reset ~ USB Commands	T2	≥50ms	ms
USB Commands ~ Touch IC Reset	T3	≥600ms	ms
Touch IC Reset ~ Touch IC Sensing Start	T4	≥500ms	ms
Touch IC Reset low-level width	T5	≥10	us

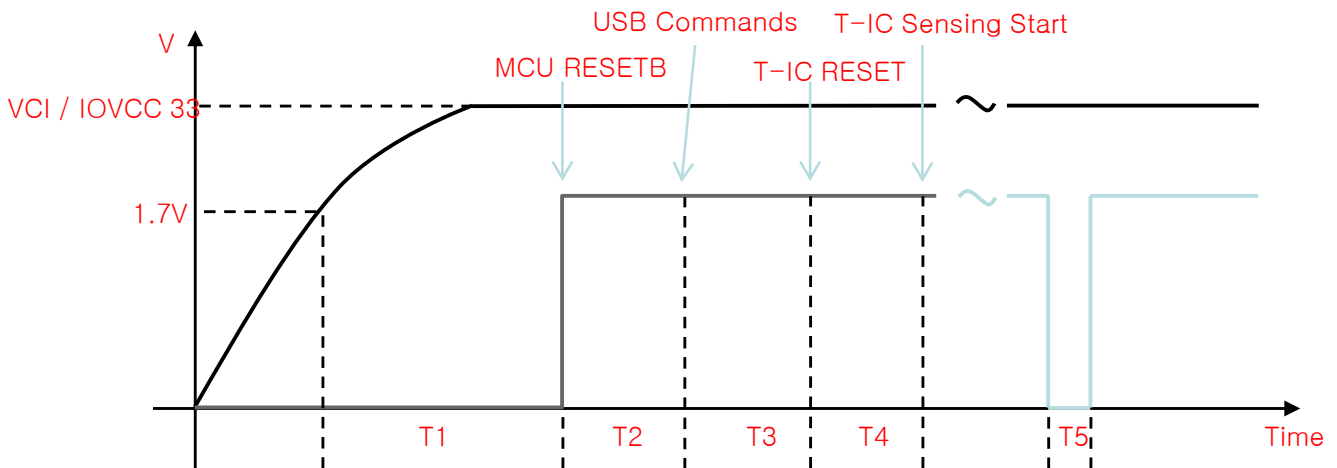

**7.0 INPUT SIGNALS, BASIC DISPLAY COLORS & GRAY SCALE OF COLORS**

	Colors & Gray scale	Data signal																	
		R0	R1	R2	R3	R4	R5	G0	G1	G2	G3	G4	G5	B0	B1	B2	B3	B4	B5
Basic colors	Black	0	0	0	0	0	0	0	0	0	0	0	0	0	0	0	0	0	0
	Blue	0	0	0	0	0	0	0	0	0	0	0	0	1	1	1	1	1	1
	Green	0	0	0	0	0	0	1	1	1	1	1	1	0	0	0	0	0	0
	Light Blue	0	0	0	0	0	0	1	1	1	1	1	1	1	1	1	1	1	1
	Red	1	1	1	1	1	1	0	0	0	0	0	0	0	0	0	0	0	0
	Purple	1	1	1	1	1	1	0	0	0	0	0	0	1	1	1	1	1	1
	Yellow	1	1	1	1	1	1	1	1	1	1	1	1	0	0	0	0	0	0
	White	1	1	1	1	1	1	1	1	1	1	1	1	1	1	1	1	1	1
Gray scale of Red	Black	0	0	0	0	0	0	0	0	0	0	0	0	0	0	0	0	0	0
	△	1	0	0	0	0	0	0	0	0	0	0	0	0	0	0	0	0	0
	Darker	0	1	0	0	0	0	0	0	0	0	0	0	0	0	0	0	0	0
	△																		
	▽																		
	Brighter	1	0	1	1	1	1	0	0	0	0	0	0	0	0	0	0	0	0
Gray scale of Green	Black	0	0	0	0	0	0	0	0	0	0	0	0	0	0	0	0	0	0
	△	0	0	0	0	0	0	1	0	0	0	0	0	0	0	0	0	0	0
	Darker	0	0	0	0	0	0	0	1	0	0	0	0	0	0	0	0	0	0
	△																		
	▽																		
	Brighter	0	0	0	0	0	0	1	0	1	1	1	1	0	0	0	0	0	0
Gray scale of Blue	Black	0	0	0	0	0	0	0	0	0	0	0	0	0	0	0	0	0	0
	△	0	0	0	0	0	0	0	0	0	0	0	0	1	0	0	0	0	0
	Darker	0	0	0	0	0	0	0	0	0	0	0	0	0	1	0	0	0	0
	△																		
	▽																		
	Brighter	0	0	0	0	0	0	0	0	0	0	0	0	1	0	1	1	1	1
Gray scale of White & Black	Black	0	0	0	0	0	0	0	0	0	0	0	0	0	0	0	0	0	0
	△	1	0	0	0	0	0	1	0	0	0	0	0	1	0	0	0	0	0
	Darker	0	1	0	0	0	0	0	1	0	0	0	0	0	1	0	0	0	0
	△																		
	▽																		
	Brighter	1	0	1	1	1	1	1	0	1	1	1	1	1	0	1	1	1	1
White	1	1	1	1	1	1	1	1	1	1	1	1	1	1	1	1	1	1	

### 8.0 POWER SEQUENCE

To prevent a latch-up or DC operation of the LCD module, the power on/off sequence shall be as shown in below

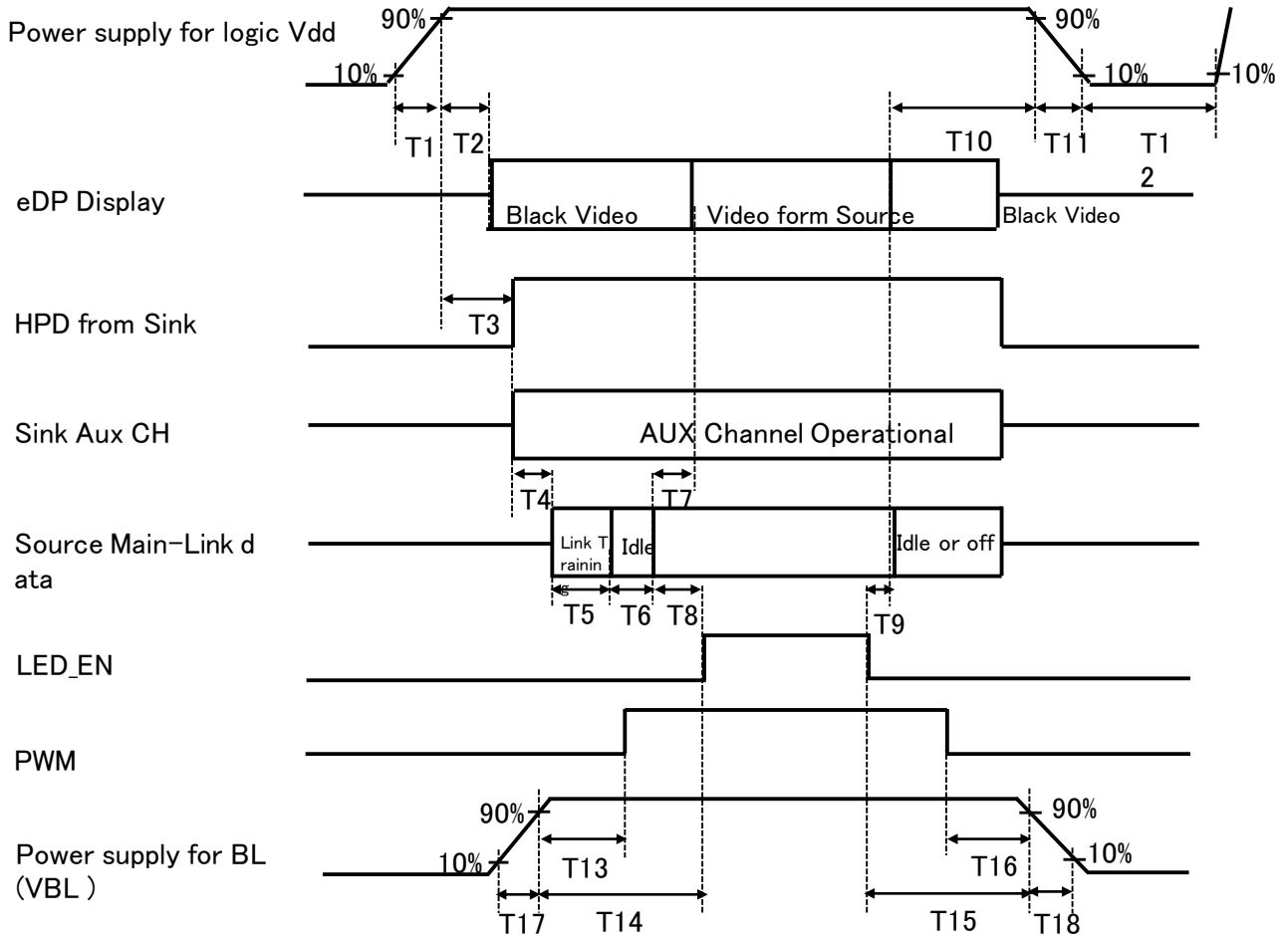

- 0.5ms ≤ T1 ≤ 10 ms
- 0ms ≤ T2 ≤ 200 ms
- 0ms ≤ T3 ≤ 200 ms
- 0ms ≤ T13
- 0ms ≤ T14
- 0ms ≤ T17
- 0ms ≤ T7 ≤ 50ms
- 0ms ≤ T10 ≤ 500 ms
- 0 ms ≤ T11 ≤ 10 ms
- 150ms ≤ T12
- 0ms ≤ T15
- 0ms ≤ T16
- 0ms ≤ T18

**Notes:**

1. When the power supply VDD is 0V, keep the level of input signals on the low or keep high impedance.
2. Do not keep the interface signal high impedance when power is on. Back Light must be turn on after power for logic and interface signal are valid.

## 9.0 MECHANICAL CHARACTERISTICS

### 9.1 Dimensional Requirements

FIGURE 6 shows mechanical outlines for the model NV156FHM-T00.

Other parameters are shown in Table 10.

<Table 10. Dimensional Parameters>

Parameter	Specification	Unit
Active Area	344.16 (H) × 193.59(V)	
Number of pixels	1920 (H) X 1080 (V) (1 pixel = R + G + B dots)	
Pixel pitch	0.17925 (H) X 0.17925 (V)	mm
Pixel arrangement	RGB Vertical stripe	
Display colors	262K	
Display mode	Normally Black	
Dimensional outline	350.76(H)*216.195(V) (W/PCB)*3.2(Max)	mm
Weight	385(Max)	gram
Back Light	Connector :IS050-L30B-C10	
	LED, Horizontal-LED Array type	

### 9.2 Mounting

See FIGURE 6.

### 9.3 Glare and Polarizer Hardness.

The surface of the LCD has an glare coating to maximize readability and hard coating to reduce scratching.

### 9.4 Light Leakage

There shall not be visible light from the back-lighting system around the edges of the screen as seen from a distance 50cm from the screen with an overhead light level of 350lux.

**10.0 RELIABILITY TEST**

The Reliability test items and its conditions are shown in below.

<Table 11. Reliability test>

No	Test Items	Conditions
1	High temperature storage test	Ta = 60 °C, 240 hrs
2	Low temperature storage test	Ta = -20 °C, 240 hrs
3	High temperature & high humidity operation test	Ta = 40 °C, 80%RH, 240 hrs
4	High temperature operation test	Ta = 50 °C, 240 hrs
5	Low temperature operation test	Ta = 0 °C, 240 hrs
6	Thermal shock	Ta = 20 °C ↔ 60 °C (0.5 hr), 100 cycle
7	Vibration test (non-operating)	10 ~ 1000 Hz, 10 m/s <sup>2</sup> Half Sine X,Y,Z / Sweep rate : 1 hour
8	Shock test (non-operating)	220G, Half Sine Wave 2msec ±X, ±Y, ±Z Once for each direction
9	Electro-static discharge test (non-operating)	Air : 150 pF, 330Ω, 15 KV Contact : 150 pF, 330Ω, 8 KV

**11.0 HANDLING & CAUTIONS**

(1) Cautions when taking out the module

- Pick the pouch only, when taking out module from a shipping package.

(2) Cautions for handling the module

- As the electrostatic discharges may break the LCD module, handle the LCD module with care. Peel a protection sheet off from the LCD panel surface as slowly as possible.
- As the LCD panel and back - light element are made from fragile glass material, impulse and pressure to the LCD module should be avoided.
- As the surface of the polarizer is very soft and easily scratched, use a soft dry cloth without chemicals for cleaning.
- Do not pull the interface connector in or out while the LCD module is operating.
- Put the module display side down on a flat horizontal plane.
- Handle connectors and cables with care.

(3) Cautions for the operation

- When the module is operating, do not lose CLK, ENAB signals. If any one of these signals is lost, the LCD panel would be damaged.
- Obey the supply voltage sequence. If wrong sequence is applied, the module would be damaged.



PRODUCT GROUP		REV	ISSUE DATE	<b>BOE</b>
TLCM PRODUCT		P1	2016.08.12	
SPEC. NUMBER	SPEC. TITLE			PAGE
	NV156FHM-T00 Preliminary Product Specification			25 OF 32

(4) Cautions for the atmosphere

- Dew drop atmosphere should be avoided.
- Do not store and/or operate the LCD module in a high temperature and/or humidity atmosphere. Storage in an electro-conductive polymer packing pouch and under relatively low temperature atmosphere is recommended.

(5) Cautions for the module characteristics

- Do not apply fixed pattern data signal to the LCD module at product aging.
- Applying fixed pattern for a long time may cause image sticking.

(6) Other cautions

- Do not disassemble and/or re-assemble the LCD module.
- Do not re-adjust variable resistor or switch etc.
- When returning the module for repair, etc., please ensure the module not to be broken. We recommend to use the original shipping packages.

**TBD**

**12.0 LABEL**

(1) TLCM label

NT156WHM-T00



XXXXXXXXXXXXXXXXXXXX



CN-OHXNNJ-79088-  
XXX-XXXX-X00

MADE IN CHINA

DP/N OHXNNJ





MADE IN CHINA

TLCM ID 编码规则:

序列号	1	2	3	4	5	6	7	8	9	10	11	12	13	14	15	16	17
代码																	
描述	GBN		等级	line	年	月	FG-Code后4位					Serial Number					

PRODUCT GROUP		REV	ISSUE DATE	<b>BOE</b>
TLCM PRODUCT		P1	2016.08.12	
SPEC. NUMBER	SPEC. TITLE			PAGE
	NV156FHM-T00 Preliminary Product Specification			26 OF 32

(2) High voltage caution label

	HIGH VOLTAGE CAUTION	COLD CATHODE FLUORESCENT LAMP IN LCD PANEL CONTAINS A SMALL AMOUNT OF MERCURY. PLEASE FOLLOW LOCAL ORDINANCES OR REGULATIONS FOR DISPOSAL.
	RISK OF ELECTRIC SHOCK. DISCONNECT THE ELECTRIC POWER BEFORE SERVICING	

(3) Box label

**BOE** CHONGCHING BOE ELECTRONICS TECHNOLOGY CO., LTD

MODEL: XXXXXXX-XXX ① QTY: XX ②

SERIAL NO: XXXXXXXXXXXX ③ DATE: XXXXXXXX ④

BOX ID 条形码

XXXXXXXXXX ⑤ XXXX ⑥ XXXX ⑦

RoHS Compliant

蓝色字体为后打印标识, 说明如下:

1. FG-CODE
2. Box 产品数量
3. Box ID, 编码规则如下
4. Box Packing 日期
5. 产品物料号(客户端)
6. FG-CODE 后四位

Box ID 编码规则

序号号	1	2	3	4	5	6	7	8	9	10	11	12	13
代码	S	L	S	T	1	4	3	D	0	0	1	H	D
描述	GBN代码		等级	TM1	年份		月	Rev	Serial Number				

PRODUCT GROUP		REV	ISSUE DATE	<b>BOE</b>
TLCM PRODUCT		P1	2016.08.12	
SPEC. NUMBER	SPEC. TITLE			PAGE
	NV156FHM-T00 Preliminary Product Specification			27 OF 32

## 13.0 PACKING INFORMATION

### 13.1 Packing order

- Put Pad into the inner box

- Put module into the paper spacer and modules bundled by PE Bag

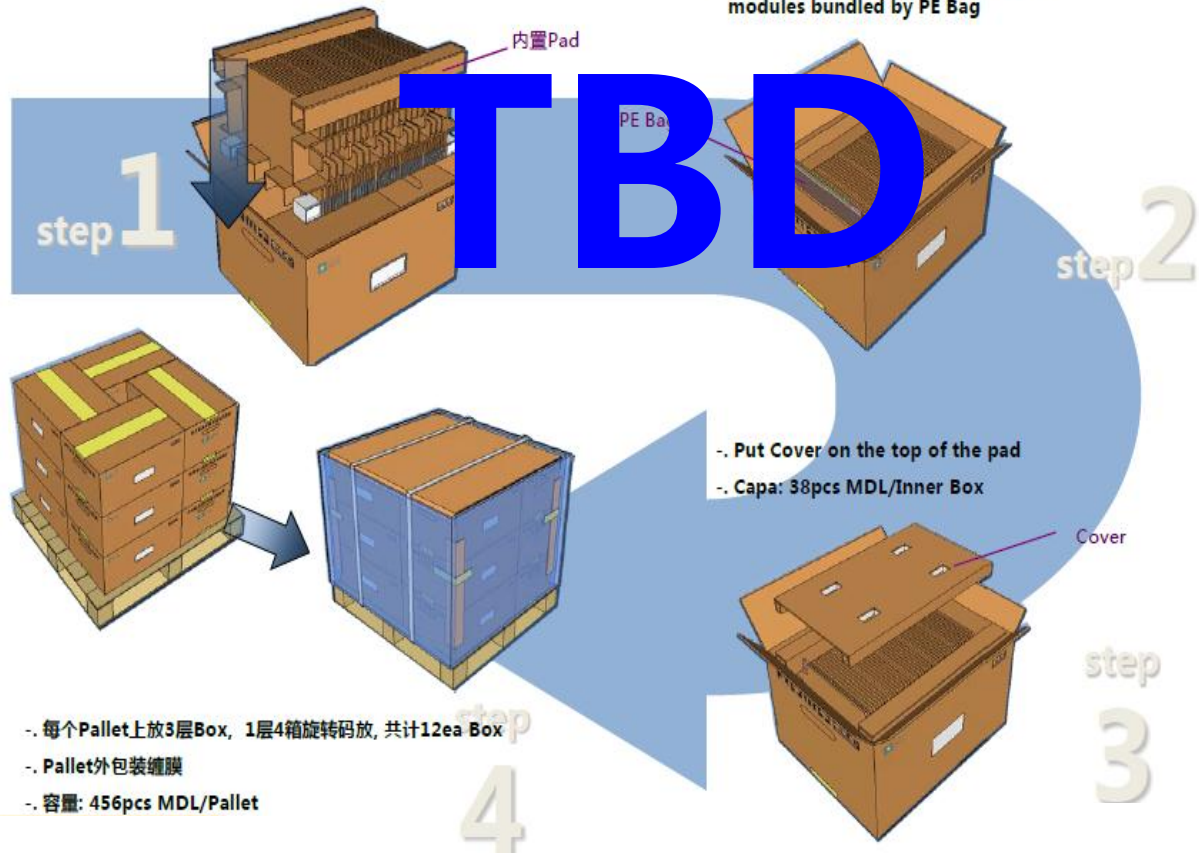

### 13.2 Notes

- Box Dimension: TBD
- Package Quantity in one Box: pcs
- Total Weight: TBD

**14. MECHANICAL OUTLINE DIMENSION**

**14.1 Outline Dimension**

Figure 6. Outline Dimensions (Front view)

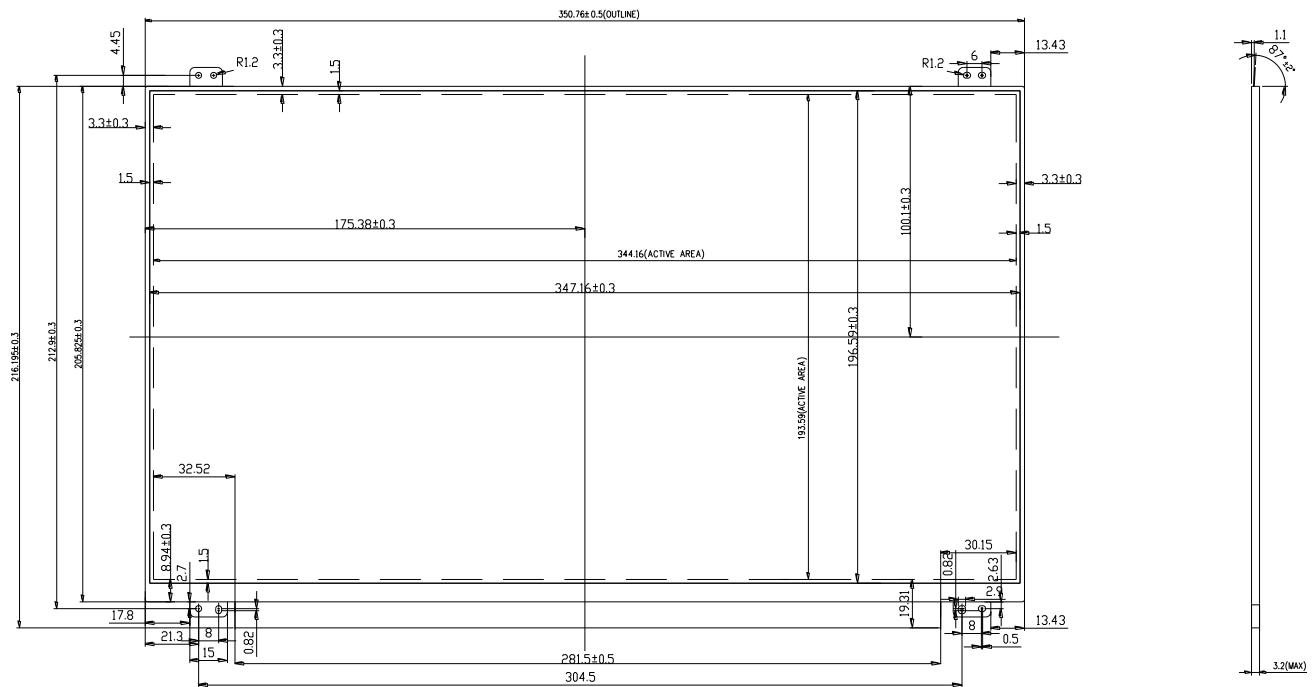

**Note**

1. PCB side is lower than Top Polarizer, and any other PCB component is lower than Top Polarizer.
2. Warps and Deformation are 0≤d≤0.5mm MAX.
3. No light leakage from all 4 corners of LCM.
4. Screw Bracket Angle is 87°±2°.



14.2 Total Solution Outline Dimension

Figure 7. Outline Dimensions (Rear view)

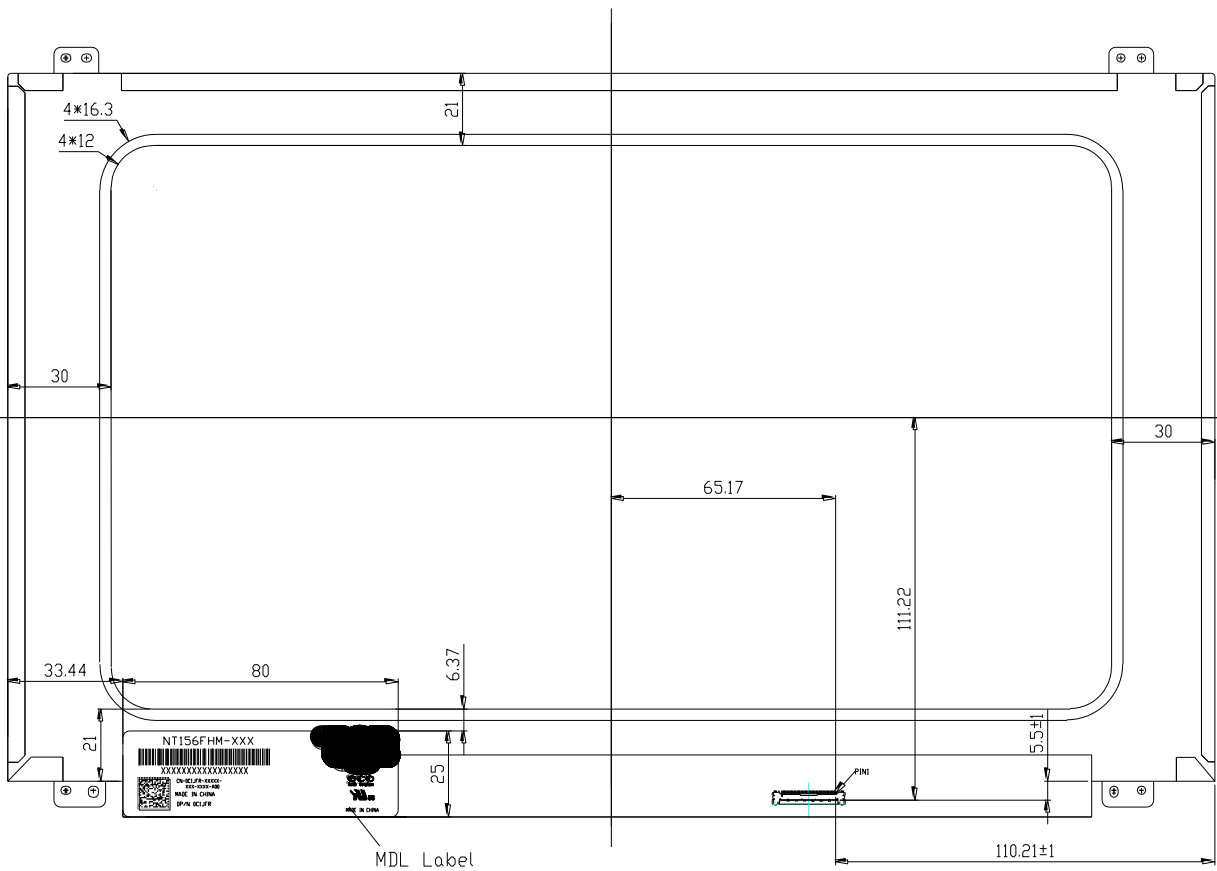

**15.0 EDID Table**

Addresses (HEX)	Function	Hex	Dec	crc	Input values.	Notes
00	Header	00	0		0	EDID Header
01		FF	255		255	
02		FF	255		255	
03		FF	255		255	
04		FF	255		255	
05		FF	255		255	
06		FF	255		255	
07		00	0		0	
08	ID Manufacturer Name	09	9		BOE	ID = BOE
09		E5	229			
0A	ID Product Code	DD	221		1757	ID = 1757
0B		06	6			
0C		00	0			
0D	32-bit serial No.	00	0			
0E		00	0			
0F		00	0			
10		00	0			
10	Week of manufacture	01	1		1	
11	Year of Manufacture	1A	26		2016	Manufactured in 2016
12	EDID Structure Ver.	01	1		1	EDID Ver 1.0
13	EDID revision #	04	4		4	EDID Rev. 0.4
14	Video input definition	95	149		-	digital signal/DP input
15	Max H image size	22	34		34	34 cm (Approx)
16	Max V image size	13	19		19	19 cm (Approx)
17	Display Gamma	78	120		2.2	Gamma curve = 2.2
18	Feature support	02	2			RGB display, Preferred Timming mode/RGB 4:4:4
19	Red/Green low bits	C9	201		-	Red / Green Low Bits
1A	Blue/White low bits	A0	160		-	Blue / White Low Bits
1B	Red x high bits	95	149	599	0.585	Red (x) = 10010101 (0.585)
1C	Red y high bits	5D	93	372	0.364	Red (y) = 01011101 (0.364)
1D	Green x high bits	59	89	358	0.350	Green (x) = 01011001 (0.35)
1E	Green y high bits	94	148	593	0.580	Green (y) = 10010100 (0.58)
1F	Blue x high bits	29	41	166	0.163	Blue (x) = 00101001 (0.163)
20	Blue y high bits	24	36	146	0.143	Blue (y) = 00100100 (0.143)
21	White x high bits	50	80	320	0.313	White (x) = 01010000 (0.313)
22	White y high bits	54	84	336	0.329	White (y) = 01010100 (0.329)
23	Established timing 1	00	0		-	
24	Established timing 2	00	0		-	

25	Established timing 3	00	0		-	
26	Standard timing #1	01	1			Not Used
27		01	1			
28	Standard timing #2	01	1			Not Used
29		01	1			
2A	Standard timing #3	01	1			Not Used
2B		01	1			
2C	Standard timing #4	01	1			Not Used
2D		01	1			
2E	Standard timing #5	01	1			Not Used
2F		01	1			
30	Standard timing #6	01	1			Not Used
31		01	1			
32	Standard timing #7	01	1			Not Used
33		01	1			
34	Standard timing #8	01	1			Not Used
35		01	1			
36	Detailed timing/monitor descriptor #1	9C	156		152.6	152.6MHz Main clock
37		3B	59			
38		80	128		1920	Hor Active = 1920
39		36	54		310	Hor Blanking = 310
3A		71	113		-	4 bits of Hor. Active + 4 bits of Hor. Blanking
3B		38	56		1080	Ver Active = 1080
3C		3C	60		60	Ver Blanking = 60
3D		40	64		-	4 bits of Ver. Active + 4 bits of Ver. Blanking
3E		30	48		48	Hor Sync Offset = 48
3F		20	32		32	H Sync Pulse Width = 32
40		36	54		3	V sync Offset = 3 line
41		00	0		6	V Sync Pulse width : 6 line
42		58	88		344	Horizontal Image Size = 344 mm (Low 8 bits)
43		C2	194		194	Vertical Image Size = 194 mm (Low 8 bits)
44		10	16		-	4 bits of Hor Image Size + 4 bits of Ver Image Size
45		00	0		0	Hor Border (pixels)
46	00	0		0	Vertical Border (Lines)	
47	1A	26			Refer to right table	

48	Detailed timing/monitor descriptor #2	FA	250		117.7	117.7MHz Main clock
49		2D	45			
4A		80	128		1920	Hor Active = 1920
4B		0E	14		270	Hor Blanking = 270
4C		71	113		-	4 bits of Hor. Active + 4 bits of Hor. Blanking
4D		38	56		1080	Ver Active = 1080
4E		28	40		40	Ver Blanking = 40
4F		40	64		-	4 bits of Ver. Active + 4 bits of Ver. Blanking
50		30	48		48	Hor Sync Offset = 48
51		20	32		32	H Sync Pulse Width = 32
52		36	54		3	V sync Offset = 3 line
53		00	0		6	V Sync Pulse width : 6 line
54		58	88		344	Horizontal Image Size = 344 mm (Low 8 bits)
55		C2	194		194	Vertical Image Size = 194 mm (Low 8 bits)
56		10	16		-	4 bits of Hor Image Size + 4 bits of Ver Image Size
57		00	0		0	Hor Border (pixels)
58		00	0		0	Vertical Border (Lines)
59	1A	26		0		
5A	Detailed timing/monitor descriptor #3	00	0			ASCII Data Sting Tag
5B		00	0			
5C		00	0			
5D		FE	254			
5E		00	0			
5F		42	66		B	Manufacture name : BOECQ
60		4F	79		O	
61		45	69		E	
62		20	32			
63		43	67		C	
64		51	81		Q	
65		0A	10			
66		20	32			
67		20	32			
68	20	32				
69	20	32				
6A	20	32				
6B	20	32				



6C	Detailed timing/monitor descriptor #4	00	0			Product Name Tag (ASCII)
6D		00	0			
6E		00	0			
6F		FE	254			
70		00	0			
71		4E	78		N	Model name : NV156FHM-T00
72		56	86		V	
73		31	49		1	
74		35	53		5	
75		36	54		6	
76		46	70		F	
77		48	72		H	
78		4D	77		M	
79		2D	45		-	
7A		54	84		T	
7B		30	48		0	
7C	30	48		0		
7D	0A	10				
7E	Extension flag	00	0			
7F	Checksum	26	38	38	-	